

Data Sheet



Article number: 23110111004

Description: E+G Column level indicator
HCK.76-GL-M10, for glycol-based solutions

Measures

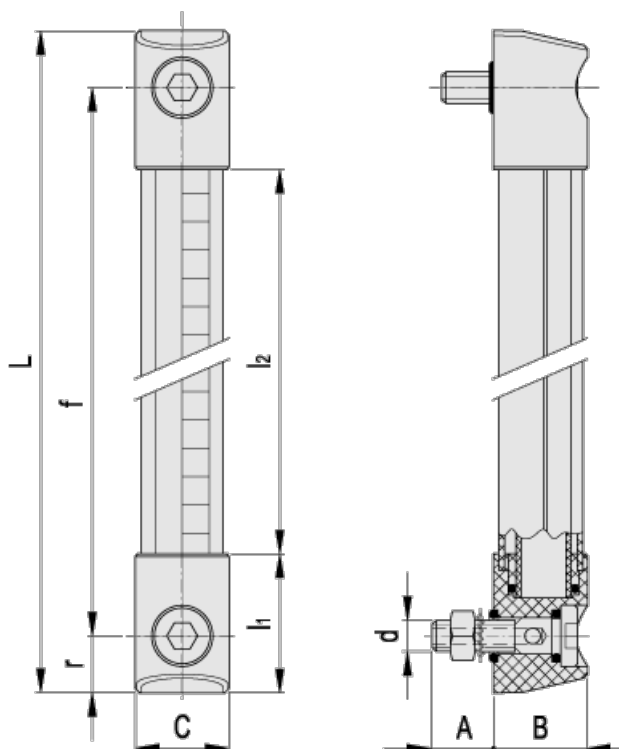

A = 20

r = 18.5

B = 33

C = 33

d = M10

f = 76

L = 113

l1 = 35.5

l2 = 42